



Linear Heat Detection System Guide

This page is intentionally left blank.

Intellectual Property and Copyright

This document includes registered and unregistered trademarks. All trademarks displayed are the trademarks of their respective owners. Your use of this document does not constitute or create a licence or any other right to use the name and/or trademark and/or label.

This document is subject to copyright owned by Eurofyre Limited. You agree not to copy, communicate to the public, adapt, distribute, transfer, sell, modify or publish any contents of this document without the express prior written consent of Eurofyre.

Disclaimer

The contents of this document is provided on an “as is” basis. No representation or warranty (either express or implied) is made as to the completeness, accuracy or reliability of the contents of this document. The manufacturer reserves the right to change designs or specifications without obligation and without further notice. Except as otherwise provided, all warranties, express or implied, including without limitation any implied warranties of merchantability and fitness for a particular purpose are expressly excluded.

General Warning

This product must only be installed, configured and used strictly in accordance with the General Terms and Conditions, User Manual and product documents available from Eurofyre. All proper health and safety precautions must be taken during the installation, commissioning and maintenance of the product. The system should not be connected to a power source until all the components have been installed. Proper safety precautions must be taken during tests and maintenance of the products when these are still connected to the power source. Failure to do so or tampering with the electronics inside the products can result in an electric shock causing injury or death and may cause equipment damage. Eurofyre is not responsible and cannot be held accountable for any liability that may arise due to improper use of the equipment and/or failure to take proper precautions. Only persons trained through an Eurofyre accredited training course can install, test and maintain the system.

Liability

You agree to install, configure and use the products strictly in accordance with the User Manual and product documents available from Eurofyre.

Eurofyre is not liable to you or any other person for incidental, indirect, or consequential loss, expense or damages of any kind including without limitation, loss of business, loss of profits or loss of data arising out of your use of the products. Without limiting this general disclaimer the following specific warnings and disclaimers also apply:

Fitness for Purpose

You agree that you have been provided with a reasonable opportunity to appraise the products and have made your own independent assessment of the fitness or suitability of the products for your purpose. You acknowledge that you have not relied on any oral or written information, representation or advice given by or on behalf of Eurofyre or its representatives.

Total Liability

To the fullest extent permitted by law that any limitation or exclusion cannot apply, the total liability of Eurofyre in relation to the products is limited to:

- in the case of services, the cost of having the services supplied again; or
- in the case of goods, the lowest cost of replacing the goods, acquiring equivalent goods or having the goods repaired.

Indemnification

You agree to fully indemnify and hold Eurofyre harmless for any claim, cost, demand or damage (including legal costs on a full indemnity basis) incurred or which may be incurred arising from your use of the products.

Miscellaneous

If any provision outlined above is found to be invalid or unenforceable by a court of law, such invalidity or unenforceability will not affect the remainder which will continue in full force and effect. All rights not expressly granted are reserved.

Scope

The FyreLine Digital Linear Heat Detection System Guide provides a comprehensive description of the FyreLine digital linear heat detection cable and its accessories.

This guide introduces the FyreLine Digital features, technical specifications and gives an understanding of its components and their function. You will also find instructions on installing, cabling and testing.



This guide is for anyone involved with the design, maintenance and purchasing of a FyreLine Digital system. It is assumed that anyone using this product has the knowledge and appropriate certification from local fire and electrical authorities.

Document Conventions

The following typographic conventions are used in this document:

Convention	Description
Bold	Used to denote: Emphasis.
<i>Italics</i>	Used to denote: References to other parts of this document or other documents.

The following icons are used in this document:

Convention	Description
	Recommended guideline: Advising to do so.
	Caution: Not appropriate to do so or; care taken to avoid danger or mistakes.

Contact Us

Telephone	+44 (0) 1329 835 024
Email	sales@eurofyre.co.uk technical@eurofyre.co.uk
Website	www.eurofyre.co.uk

Table Of Contents

1	Product Range	6
2	Digital Sensor Cable Overview	7
	2.1 Technical Specification.....	8
3	Typical System Wiring Configuration.....	9
	3.1 Conventional Fire Alarm Systems	9
	3.2 Addressable Fire Alarm Systems	10
	3.3 Alarm Point Distance Locator	11
4	Application Guidelines	12
	4.1 Cable Trays.....	12
	4.2 Conveyor Belts	13
	4.3 Rack Storage.....	14
	4.4 Floating Roof Storage Tanks.....	15
5	Design Guidelines.....	16
	5.1 Area Protection	16
	5.2 Low Temperature Installation Considerations.....	16
6	Installation Specifications.....	17
	6.1 Leader Cable	17
	6.2 Sensor Cable	17
7	Installation Hardware	17
	7.1 “L” Brackets	18
	7.2 “V” Clips	18
	7.3 Other Support Brackets	18
8	Sensor Cable Installation.....	19
	8.1 Sensor Cable Installation Guidelines	19
	8.2 Sensor Splicing.....	20
9	Sensor Cable Testing And Verification	20
10	Functional Testing.....	20

1 Product Range

The FyreLine Digital linear heat detection system consists of a single cable type with different protective outer sheaths plus an optional Digital Alarm Distance Locator.

Optional APDL

Part No	Model No	Description
18-004	FLDDL2	Digital Interface Monitor Module, 2 Zone, 1m to 3000m (10,000ft), 12 - 36V DC

Sensor Cable

Part No	Model No	Description
Standard PVC Sensing Cable		
18-011	FLD68	Digital Linear Heat Sensing Cable, 68C Alarm Temp, PVC, UL - 100m Reel Length
18-012	FLD68	Digital Linear Heat Sensing Cable, 68C Alarm Temp, PVC, UL - 200m Reel Length
18-013	FLD68	Digital Linear Heat Sensing Cable, 68C Alarm Temp, PVC, UL - 500m Reel Length
18-014	FLD68	Digital Linear Heat Sensing Cable, 68C Alarm Temp, PVC, UL - 1000m Reel Length
18-021	FLD88	Digital Linear Heat Sensing Cable, 88C Alarm Temp, PVC, UL - 100m Reel Length
18-022	FLD88	Digital Linear Heat Sensing Cable, 88C Alarm Temp, PVC, UL - 200m Reel Length
18-023	FLD88	Digital Linear Heat Sensing Cable, 88C Alarm Temp, PVC, UL - 500m Reel Length
18-024	FLD88	Digital Linear Heat Sensing Cable, 88C Alarm Temp, PVC, UL - 1000m Reel Length
18-031	FLD105	Digital Linear Heat Sensing Cable, 105C Alarm Temp, PVC, UL - 100m Reel Length
18-032	FLD105	Digital Linear Heat Sensing Cable, 105C Alarm Temp, PVC, UL - 200m Reel Length
18-033	FLD105	Digital Linear Heat Sensing Cable, 105C Alarm Temp, PVC, UL - 500m Reel Length
18-034	FLD105	Digital Linear Heat Sensing Cable, 105C Alarm Temp, PVC, UL - 1000m Reel Length
Nylon Coating for Outdoor UV Protection & Increased Durability		
18-041	FLD68N	Digital Linear Heat Sensing Cable, 68C Alarm Temp, Nylon Coated, 100m Reel Length
18-042	FLD68N	Digital Linear Heat Sensing Cable, 68C Alarm Temp, Nylon Coated, 200m Reel Length
18-043	FLD68N	Digital Linear Heat Sensing Cable, 68C Alarm Temp, Nylon Coated, 500m Reel Length
18-044	FLD68N	Digital Linear Heat Sensing Cable, 68C Alarm Temp, Nylon Coated, 1000m Reel Length
18-045	FLD68NS	Digital Linear Heat Sensing Cable, 68C Alarm Temp, Nylon, SS Braided, 100m Reel Length
18-046	FLD68NS	Digital Linear Heat Sensing Cable, 68C Alarm Temp, Nylon, SS Braided, 200m Reel Length
18-047	FLD68NS	Digital Linear Heat Sensing Cable, 68C Alarm Temp, Nylon, SS Braided, 500m Reel Length
18-048	FLD68NS	Digital Linear Heat Sensing Cable, 68C Alarm Temp, Nylon, SS Braided, 1000m Reel Length
18-051	FLD88N	Digital Linear Heat Sensing Cable, 88C Alarm Temp, Nylon Coated, 100m Reel Length
18-052	FLD88N	Digital Linear Heat Sensing Cable, 88C Alarm Temp, Nylon Coated, 200m Reel Length
18-053	FLD88N	Digital Linear Heat Sensing Cable, 88C Alarm Temp, Nylon Coated, 500m Reel Length
18-054	FLD88N	Digital Linear Heat Sensing Cable, 88C Alarm Temp, Nylon Coated, 1000m Reel Length
18-055	FLD88NS	Digital Linear Heat Sensing Cable, 88C Alarm Temp, Nylon, SS Braided, 100m Reel Length
18-056	FLD88NS	Digital Linear Heat Sensing Cable, 88C Alarm Temp, Nylon, SS Braided, 200m Reel Length
18-057	FLD88NS	Digital Linear Heat Sensing Cable, 88C Alarm Temp, Nylon, SS Braided, 500m Reel Length
18-058	FLD88NS	Digital Linear Heat Sensing Cable, 88C Alarm Temp, Nylon, SS Braided, 1000m Reel Length
18-061	FLD105N	Digital Linear Heat Sensing Cable, 105C Alarm Temp, Nylon Coated, 100m Reel Length
18-062	FLD105N	Digital Linear Heat Sensing Cable, 105C Alarm Temp, Nylon Coated, 200m Reel Length
18-063	FLD105N	Digital Linear Heat Sensing Cable, 105C Alarm Temp, Nylon Coated, 500m Reel Length
18-064	FLD105N	Digital Linear Heat Sensing Cable, 105C Alarm Temp, Nylon Coated, 1000m Reel Length

Stainless Steel Braided for Enhanced EMC & Mechanical Protection		
18-071	FLD68S	Digital Linear Heat Sensing Cable, 68C Alarm Temp, Stainless Steel Braided, 100m Reel Length
18-072	FLD68S	Digital Linear Heat Sensing Cable, 68C Alarm Temp, Stainless Steel Braided, 200m Reel Length
18-073	FLD68S	Digital Linear Heat Sensing Cable, 68C Alarm Temp, Stainless Steel Braided, 500m Reel Length
18-074	FLD68S	Digital Linear Heat Sensing Cable, 68C Alarm Temp, Stainless Steel Braided, 1000m Reel Length
18-081	FLD88S	Digital Linear Heat Sensing Cable, 88C Alarm Temp, Stainless Steel Braided, 100m Reel Length
18-082	FLD88S	Digital Linear Heat Sensing Cable, 88C Alarm Temp, Stainless Steel Braided, 200m Reel Length
18-083	FLD88S	Digital Linear Heat Sensing Cable, 88C Alarm Temp, Stainless Steel Braided, 500m Reel Length
18-084	FLD88S	Digital Linear Heat Sensing Cable, 88C Alarm Temp, Stainless Steel Braided, 1000m Reel Length
18-091	FLD105S	Digital Linear Heat Sensing Cable, 105C Alarm Temp, Stainless Steel Braided, 100m Reel Length
18-092	FLD105S	Digital Linear Heat Sensing Cable, 105C Alarm Temp, Stainless Steel Braided, 200m Reel Length
18-093	FLD105S	Digital Linear Heat Sensing Cable, 105C Alarm Temp, Stainless Steel Braided, 500m Reel Length
18-094	FLD105S	Digital Linear Heat Sensing Cable, 105C Alarm Temp, Stainless Steel Braided, 1000m Reel Length
High Temperature Sensor Cable, 185 Degrees C Alarm		
18-101	FLD185	Digital Linear Heat Sensing Cable, 185C Alarm Temp, 100m Reel Length
18-102	FLD185	Digital Linear Heat Sensing Cable, 185C Alarm Temp, 200m Reel Length
18-103	FLD185	Digital Linear Heat Sensing Cable, 185C Alarm Temp, 500m Reel Length
18-104	FLD185	Digital Linear Heat Sensing Cable, 185C Alarm Temp, 1000m Reel Length

Table 1: Product Range

2 Digital Sensor Cable Overview

FyreLine fixed temperature linear heat detection cable is constructed using a pair of tri-metallic conductors coated in advanced temperature sensitive polymers. The two conductors are twisted together to keep them under mechanical tension. A protective outer coating is extruded over the twisted pair.

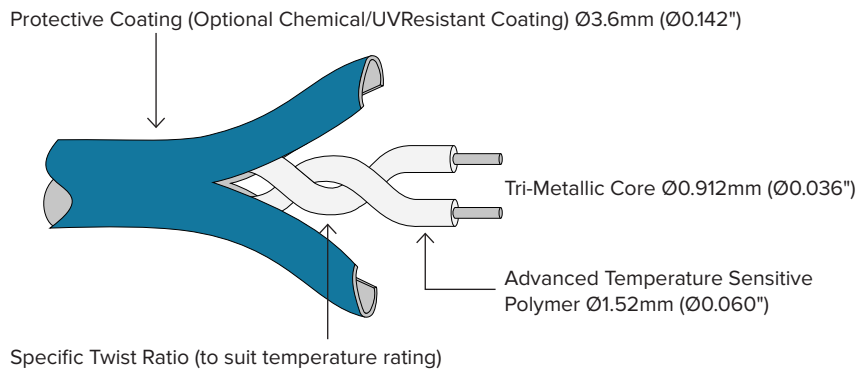

Figure 1: Fixed Temperature Linear Heat Detection Cable Construction

Alarm Point Distance Locator

An Alarm Point Distance Locator (APDL) is available to locate where along the cable a fire or overheat condition has occurred. Leader cable may be used between the control panel or switch monitor and the APDL and between the APDL and the linear heat detection cable.

2.1 Technical Specification

Construction	Overall insulated, twisted pair of tri-metallic cores
Insulation	1kV tested protective outer coat
Additional Insulation Options	Nylon Polypropylene (none UL Listed)
Approvals	CE Marked, RoHS Compliant, UL Listed
Maximum Zone Length	3,000m (10,000ft)
Wire Overall Diameter	3.60mm ± 0.12mm (0.142" ± 0.005")
(Nylon/Polypropylene Coated Diameter)	4.50mm ± 0.12mm (0.177" ± 0.005")
Minimum bend radius	50 mm (2")
Ambient Temperature Range (dependant upon action temperature)	-40°C – 125°C (-40°F – 257°F)
Electrical	
Max Voltage Rating	30Vac, 42Vdc
Resistance	~100Ω/km (29Ω/kft) per leg
Velocity of Propagation	~55%
Capacitance	88 – 150 pF/m (26 – 45 pF/ft)
Inductance	540 – 1050 nH/m (165 – 320 nH/ft)

Table 2: Cable Technical Data

2.1.1 Chemical Resistance Table

The following table provides a chemical resistance comparison for all the available outer sheath materials on the FyreLine Digital sensor cable.

Chemical	PVC	Nylon	Polypropylene
Ammonia, Liquid	*****	***	*****
Butane	*****	*****	*
Copper Nitrate	*****	*	*****
Fuel Oils	*****	*****	***
Gasoline	**	*****	**
Hydrofluoric Acid	*	*	*****
Kerosene	*****	*****	*
Diesel Fuel	*****	*****	****
Acetic Acid	**	*****	*****

Table 4: Chemical Resistance Chart

3 Typical System Wiring Configuration

3.1 Conventional Fire Alarm Systems

FyreLine fixed temperature linear heat detection (LHD) cable should be connected to the initiating device circuit on a conventional fire alarm control panel. Leader cable may be used between the beginning of the LHD cable and the fire alarm control panel if the area requiring protection is some distance away from the control panel. A junction box should be used to connect the leader cable to the linear heat detection cable to ensure a secure, waterproof electrical connection.

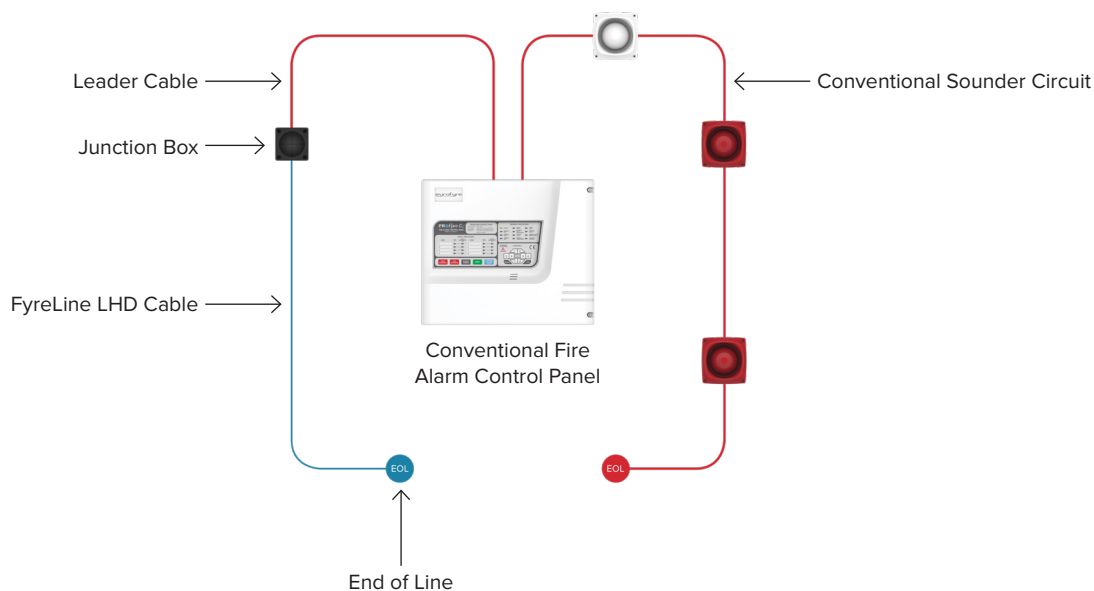

Figure 2: Typical Wiring Configuration Conventional System

3.2 Addressable Fire Alarm Systems

When used as part of an addressable system, FyreLine Linear Heat Detection cable should be connected onto the addressable loop using a switch or zone monitor. External power is not required for the Linear Heat Detection cable. Leader cable may be used between the beginning of the LHD cable and the addressable switch or zone monitor if the area requiring protection is some distance away. A junction box should be used to connect the leader cable to the linear heat detection cable to ensure a secure, waterproof electrical connection.

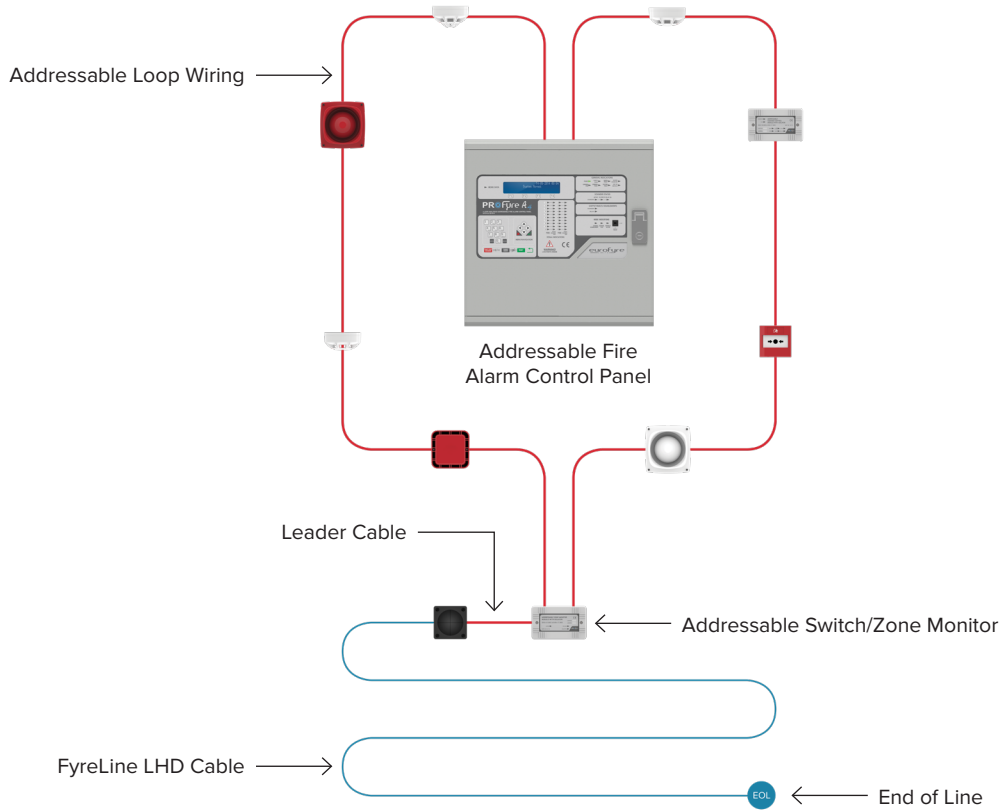

Figure 3: Typical Wiring Configuration Addressable System

3.3 Digital Interface Monitor Module

A Digital Interface Monitor Module (DiMM) is available for exclusive use with FyreLine Linear Heat Detection Cable. The DiMM allows accurate location of the point at which an alarm was triggered along the detection cable, displaying the distance in metres and feet. Leader cable can be used between the fire alarm control panel or addressable switch/zone monitor and the DiMM and between the DiMM and the Linear Heat Detection cable. A junction box should be used to connect the leader cable to the linear heat detection cable to ensure a secure, waterproof electrical connection.

Leader cable between the DiMM and the Linear Heat Detection cable can be calibrated out at the commissioning stage. Refer to the DiMM manual for more information.

Mapping of the system is important when using an Digital Interface Monitor Module. During installation draw a map to associate distances along the detection cable to locations within a building/warehouse etc. This will aid in locating the area requiring attention in an alarm condition.

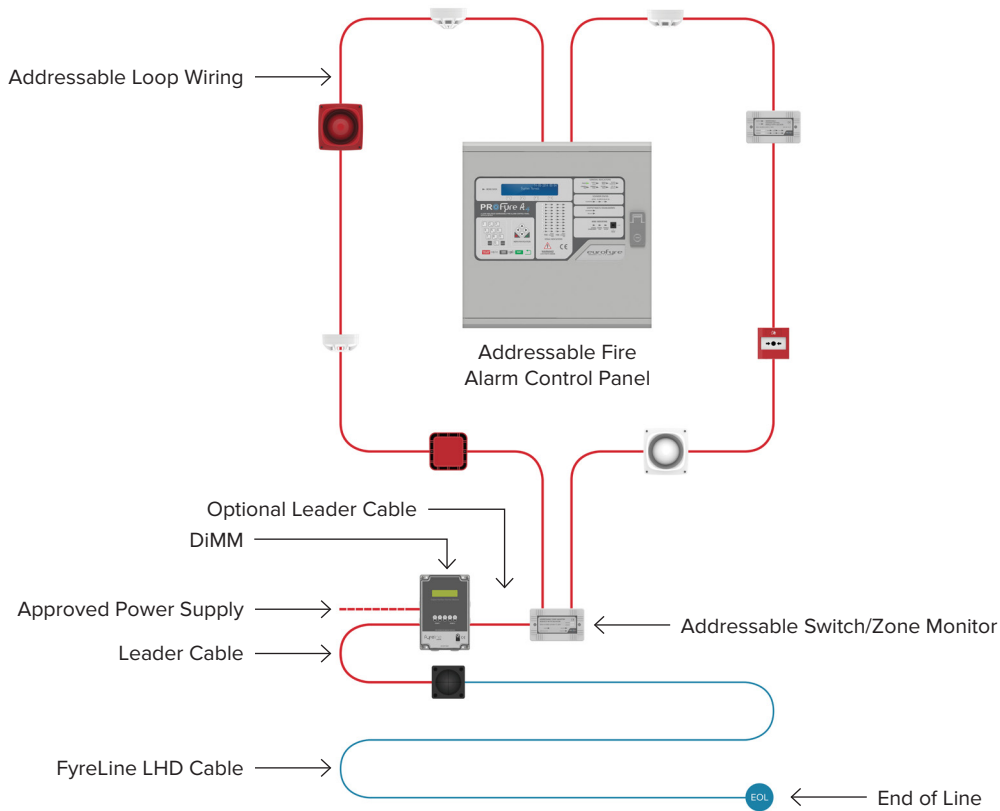



Figure 4: Typical Wiring Configuration with Digital Interface Monitor Module

4 Application Guidelines

 The following section is intended to provide a guide in designing a system for protection using Fixed Temperature Linear Heat Detection cable. Before any installation or design work is carried out however, requirements set by the NFPA, National Electrical Code or any local authority having jurisdiction should be taken into account.

Several applications are given here as examples using Linear Heat Detection cable including area detection, proximity detection, racking protection, cable trays and conveyors.

4.1 Cable Trays

Fixed Temperature Linear Heat Detection cable is ideal for protecting overheating conditions in cable trays. A sine wave pattern may be used to lay the detection cable on top of all power and control cables in a tray, spaced no more than 1.8m between peaks or troughs. Any additional cable which is laid in the tray must be laid underneath the LHD cable.

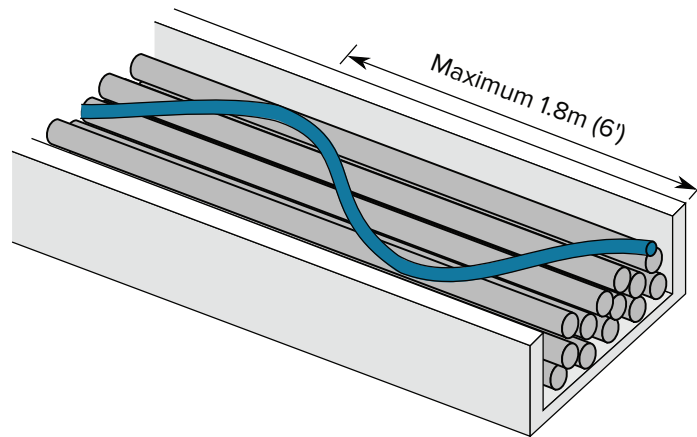

Figure 5: Sine wave pattern layout of LHD cable in a cable tray

“V” clips are ideal support for cable tray applications where multiple cable trays need protection. Maximum sensitivity to overheating conditions is provided while minimising obstruction to power or signal cables mounted on the tray.

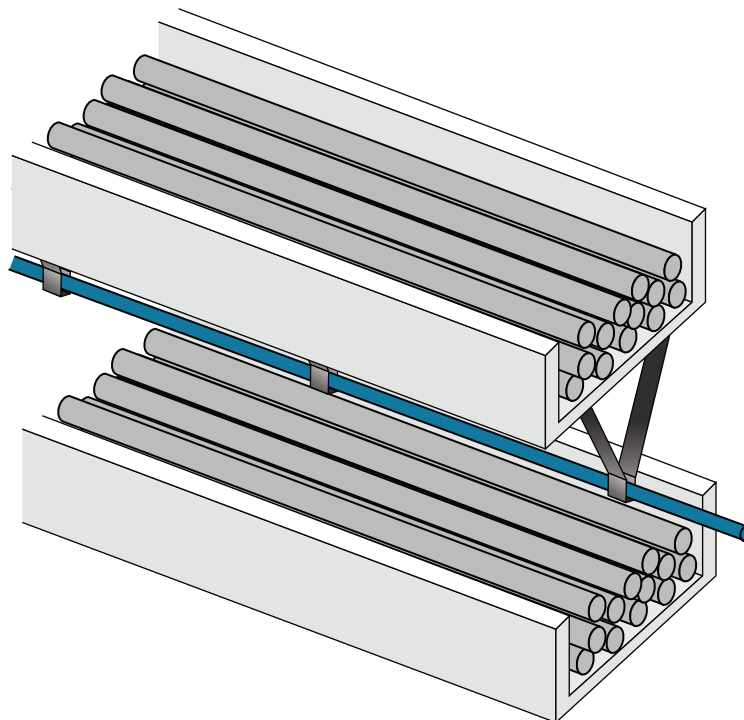

Figure 6: Protecting multiple cable trays using LHD cable

4.2 Conveyor Belts

Conveyor belt systems have several areas which have the potential to overheat and create fires. For example, it is possible for rollers to overheat and ignite the belt or product which may be on the belt or have spilled. Other areas include the hood over the conveyor belt which acts to collect heat.

A guide wire (discussed on page 17) may be required if it is not possible to space brackets close enough together to give the linear heat detection cable adequate support. Care should be taken to prevent the cable from sagging especially to prevent snagging with product on the conveyor belt.

For reliable detection of overheated conditions the linear detection cable placed overhead should be less than 2.5m (8.2ft) above the belt.

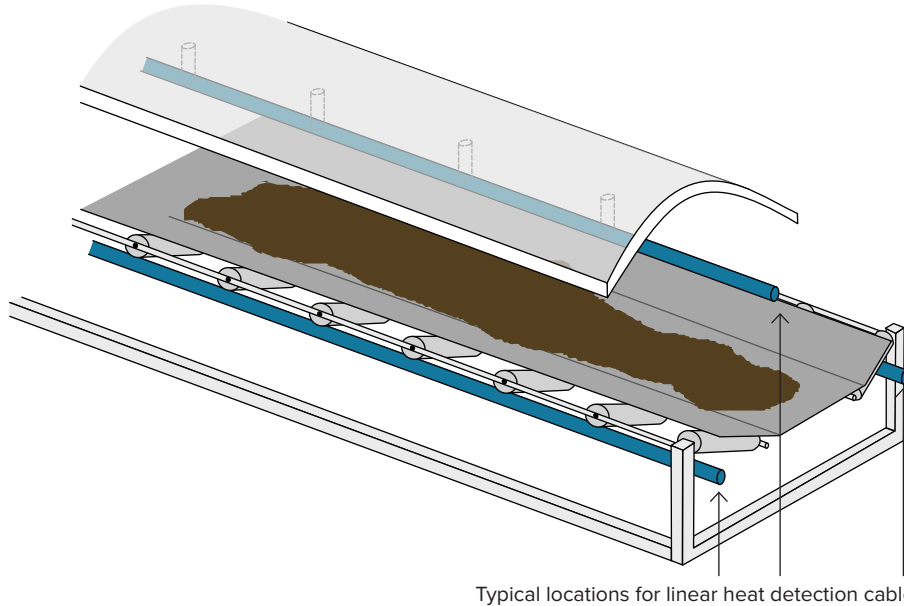

Figure 7: Typical locations for protecting conveyors with LHD cable

4.3 Rack Storage

Many different rack storage systems can be protected using Linear Heat Detection cable. Because the sensor cable can detect overheating conditions along the entire length of cable, more effective coverage is achieved than when using spot detectors. The sensor cable should be supported either:

1. On the ceiling
2. Centered over the aisles between racking
3. Parallel to the sprinkler pipe (if fitted) at the same level
4. Larger racks (over 4.5m in height) may require multiple runs of detection cable at each sprinkler level and run in the longitudinal flue space.
5. Extra protection may be provided by installing LHD cable at each level if required.

Ensure that when securing the detection cable to the racking the cable does not have the potential to be damaged by incorrectly loaded pallets or forklift operation.

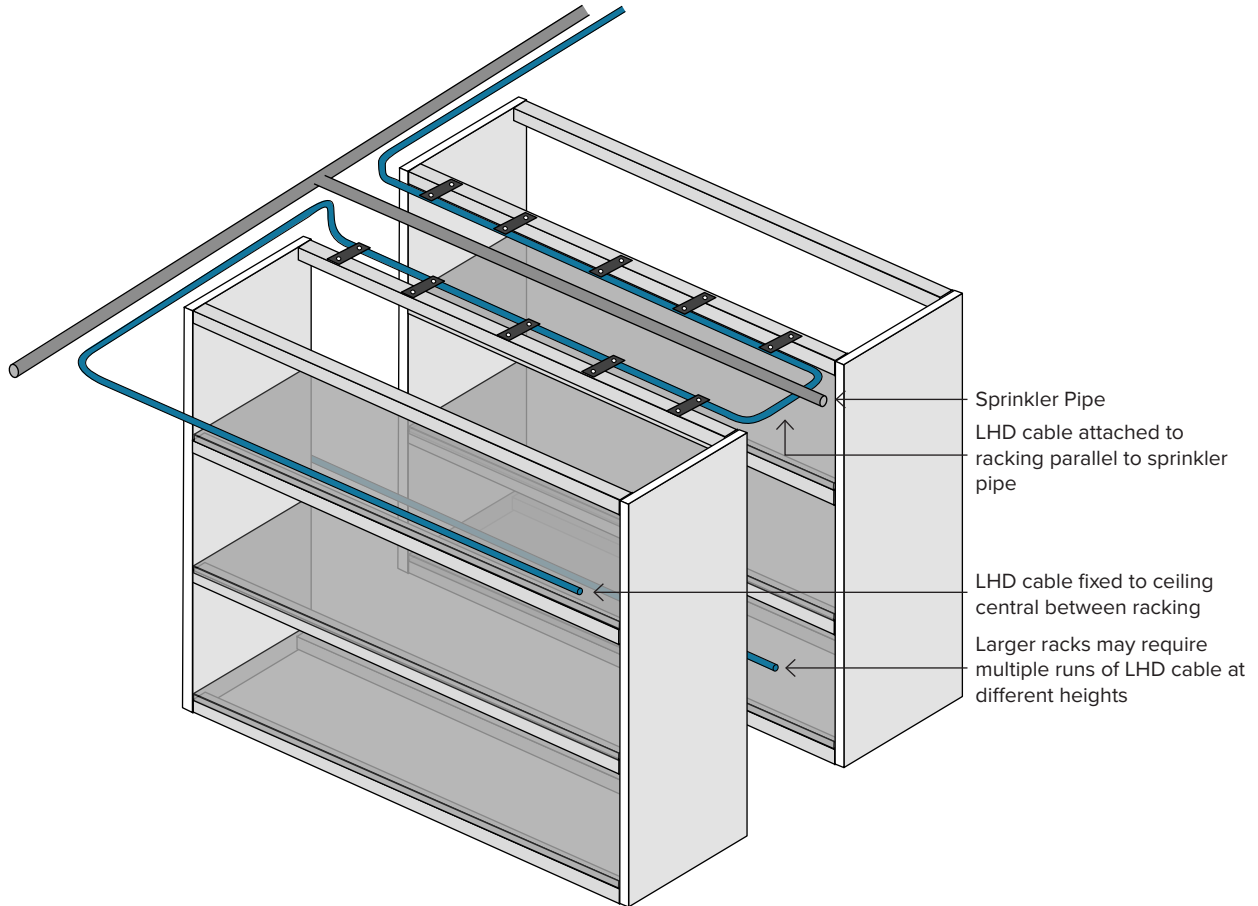

Figure 8: Typical locations for protecting racked storage with LHD cable

4.4 Floating Roof Storage Tanks

FyreLine Linear Heat Detection cable is ideal for the early warning of overheat or fire conditions on floating roof storage tanks. Best practice states that the LHD cable should be attached as close as possible to the highest point of the weather seal assembly on the roof – no more than 50mm (2”) away from it.

The cable should be located to allow for visual inspection and maintenance. Clips should be provided which are fit for purpose and securely hold the LHD cable in position. Of significant importance is the use of a retractable cable between the roof and the connection to the external control panel or junction box. Care should be taken to ensure the LHD cable cannot become snagged or placed under excessive tension with the rise and fall of the roof.

FyreLine’s Nylon coated Linear Heat Detection cable is the preferred choice for use with floating roof storage tanks due to the increased chemical resistance and UV stability. Take note of high ambient conditions which may also occur on top of floating roof storage tanks. Refer to page 17 for suitable rated detection cables with respect to ambient temperatures.

	Approved intrinsically safe barriers or galvanic isolators must be used when Linear Heat Detection cable is used in hazardous areas. Any protection devices used must meet the relevant qualifications for the zone, gas type and other requirements the cable is intended to be used in.
--	--------------------------------------------------------------------------------------------------------------------------------------------------------------------------------------------------------------------------------------------------------------------------------------------------

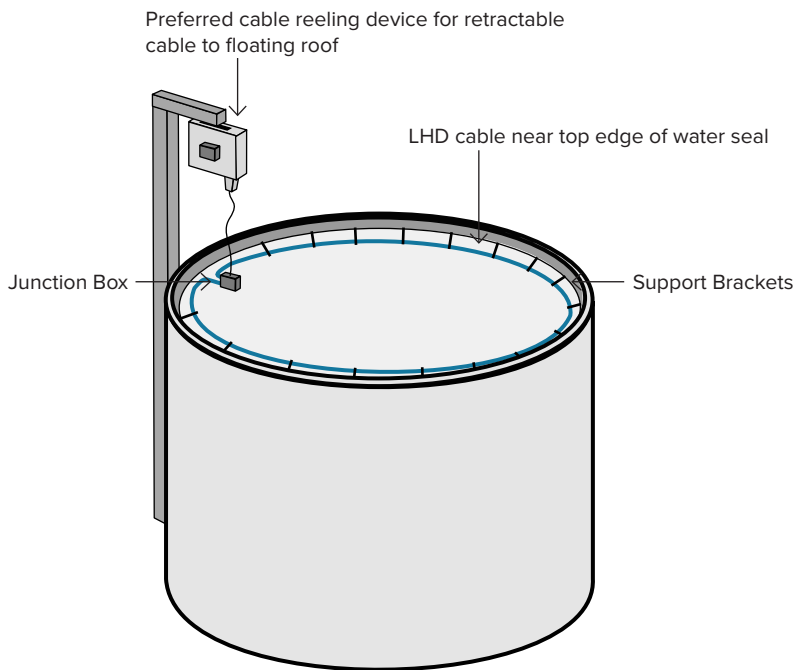

Figure 9: Typical locations for protecting floating roof storage tanks with LHD cable

5 Design Guidelines

5.1 Area Protection

FyreLine Linear Heat Detection cable is suitable for broad or wide area detection of overheat or fire conditions, e.g. warehouses etc. The LHD cable should be installed with a minimum distance between the cable and the ceiling of 20mm to allow hot gases rising from an event to trigger the detection cable.

Maximum support spacings should be followed (refer to page 9) and the cable securely attached to the ceiling or beams. For ceilings up 9m (30ft) in height maximum spacing between runs should be as in the table below. For ceilings over 9m (30ft) in height the spacings should be halved. The corresponding value in the table below should be halved for spacing between walls/partitions etc. and a run of detection cable.

FyreLine LHD Action Temperature	UL
68°C (155°F), 78°C (172°F), 88°C (190°F)	10m (35ft)
105°C (221°F)	10m (35ft)

Table 5: Cable Support Allowance

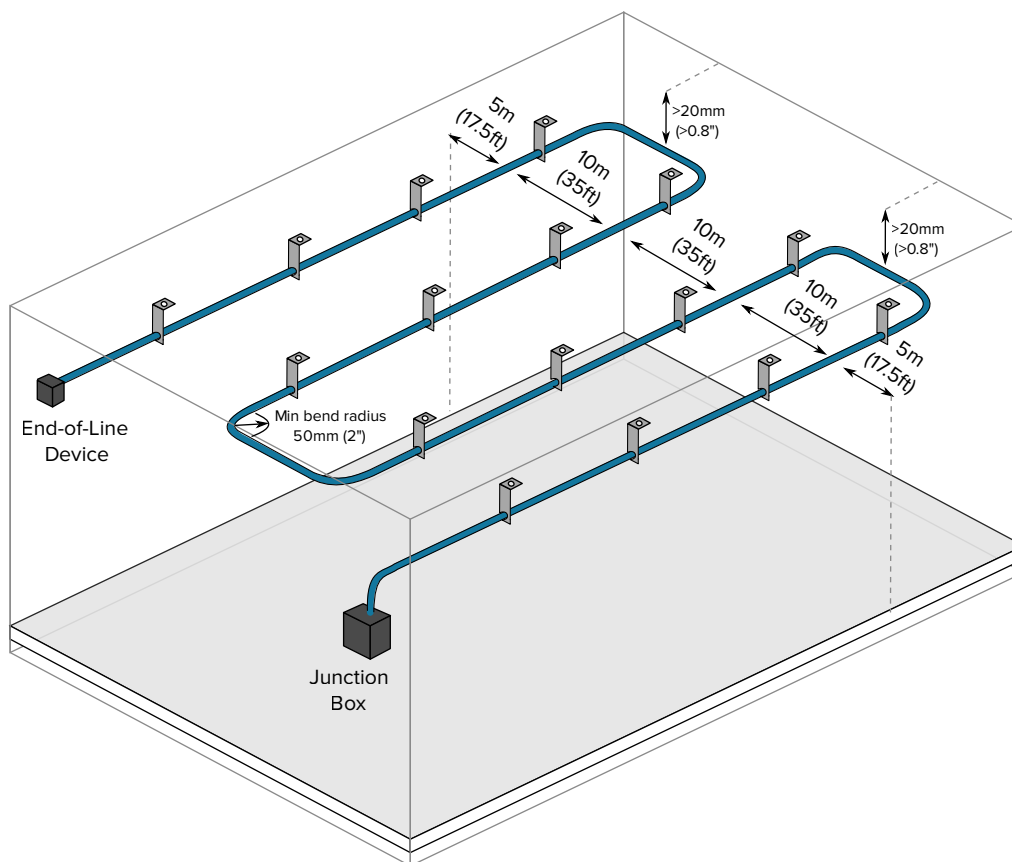

Figure 10: Protecting large areas with LHD cable

5.2 Low Temperature Installation Considerations

Fixed temperature Linear Heat Detection cable is suitable for use in ambients down to -40°C (-40°F). Such conditions occur in cold storage freezer warehouses and outdoors for example.

When installing LHD cable in low ambients or for use in low temperature conditions careful consideration of the conditions and environment should be undertaken.

Do not install the LHD cable when the ambient temperature is below -10°C (14°F). The materials within the cable will become less flexible and are more prone to damage. If the ambient temperature is likely to drop significantly after installing the cable take into account linear shrinkage of the cable when attaching support brackets. The cable can shrink in length by 1-2% at -40°C (-40°F).

A neoprene insulator should be placed around the cable before clipping into the support bracket. This prevents damage to the cable and reduces the heat sink effect of the clip.

The minimum bend radius of the detection cable should be increased to 100mm (4 inches) to account for the reduced flexibility. The maximum distance

between support brackets should be no more than 1m (3ft) and it is important to support the cable close to either side of any bend.

Ensure any junction boxes other enclosures are waterproof and suitable for the expected operating temperatures.

6 Installation Specifications

6.1 Leader Cable

An approved type of leader cable, preferably Fire Rated cable, should be used between the fire alarm control panel or addressable switch/zone monitor and the Linear Heat Detection cable. A secure waterproof (IP66/67) junction box must be used to connect the leader cable to the detection cable. It is recommended that leader cable with the following minimum cross sectional area (CSA) per conductor is used when using the maximum length of detection cable. Consult with the authority having jurisdiction and the fire alarm control panel manufacturer for further information.

Recommended Maximum Leader Cable Length and CSA for copper conductors (with maximum length of Linear Heat Detection Cable 3km/10kft)
0.8 mm ² (18AWG) — Up-to 2,500m (8,200ft)
1.3 mm ² (16AWG) — Up-to 3,500m (11,500ft)
2.0 mm ² (14AWG)— Up-to 6,000m (20,000ft)
3.3 mm ² (12AWG) — Up-to 9,500m (31,000ft)

Table 6: Leader Cable Maximum Cable Length

6.2 Sensor Cable

A very important factor in determining which rating of fixed temperature linear heat detection (LHD) cable to use is the maximum ambient temperature the cable will be exposed to. To provide the fastest alarm response but lowest possibility for false alarms the detection cable with the lowest action temperature above the maximum ambient temperature should be chosen. For example, if the maximum ambient temperature is determined to be 55°C (131°F), a detection cable with an action temperature of 88°C (190°F) should be chosen (if the fastest possible response time is required).

Maximum Ambient Temperature	Available Action Temperatures
Up to 45°C (113°F)	68°C (155°F), 78°C (172°F)
Up to 70°C (158°F)	88°C (190°F), 105°C (221°F)
Up to 125°C (257°F)	185°C (365°F)

Table 7: Detection Cable Selection

7 Installation Hardware

There are many applications which Linear Heat Detection cable is used to provide protection for. The following section intends to provide a guideline and recommendation on the types of fittings which should be used. The list is not exhaustive, however, any fitting not mentioned here which may be used should be evaluated to ensure it is fit for purpose. Consult the authority having jurisdiction for more information.

The linear heat detection cable should be adequately supported to prevent sagging. Ideally cable supports should be placed every 0.5m (1.64ft) and no more than 1.5m (5ft) apart. It may be necessary to place more supports around corners and other transition areas.

Care should be taken when mounting the cable in clips (or equivalent) that they are not done so tight as to crush the cable. The detection cable should be held firmly without deformation. Avoid placing excessive tension in the cable, no greater than 50N. Ensure also that the minimum bend radius is observed at all times – 50mm (2”).

It is of particular importance to use a neoprene insulator between the heat sensing cable and the fixing clip if the metal clip is exposed to the sun or attached to a piece of equipment which may get hot and transfer the heat to the cable.

Where possible, it is preferable to install the linear heat detection cable in one continuous run of cable with as few splices as possible.

When pulling the detection cable from a reel, a reel stand must be used. Do not pull the cable off the reel vertically with the reel stationary as this will twist and damage the cable. A guide wire may be required for installations where supporting the cable at the recommended spacing is not practical. Ensure the diameter or gauge of the guide wire is adequate for the distance which is being spanned. Commercially available stainless steel wire with a diameter of approximately 2mm is suitable for use as a guide wire.

Connections into junction boxes and other enclosures must use strain relief connectors which provide dust and moisture protection (IP65 or greater protection). The standard diameter of detection cable is 3.6mm (0.142”) to 4.5mm (0.177”). Suitable cable glands are shown opposite which fit an M12 standard knockout.

7.1 “L” Brackets

For general support of cable. Various sizes available. Position and number of fixing holes variable.



Figure 11: Typical “L” Bracket for supporting Linear Heat Detection cable

7.2 “V” Clips

For use on cable trays. A neoprene insulator should be used when clipping the detection cable into the clip. Made from spring steel.

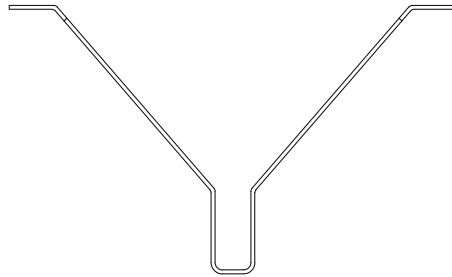

Figure 12: Typical “V” Bracket for supporting Linear Heat Detection cable

7.3 Other Support Brackets

For use in a wide variety of applications. Available in mild and stainless steel. Variable sizes. Position and number of holes variable.



















Ensure any brackets or clips chosen to hold the Linear Heat Detection Cable are fixed securely and meet the criteria specified in this instruction manual.

8 Sensor Cable Installation

8.1 Sensor Cable Installation Guidelines

Please read this instruction leaflet thoroughly before commencing installation.

	Install the linear heat detection cable accordingly to meet local and country installation requirements.
	FyreLine linear heat detection cable must be installed in accordance with NFPA 70 & 72, NEC 760 (National Electric Code) and Authorities Having Jurisdiction.
	Support the detection cable at 0.5m (1.64ft) to 1.5m (5ft) intervals.
	Test the detection cable before installation using a multimeter.
	Ensure the maximum ambient temperature rating of the detection cable will not be exceeded during storage or normal operating conditions.
	Ensure the detection cable is spaced at less than or equal to the maximum approved spacing.
	Ensure the detection cable is not in contact with any material which may conduct heat onto the cable directly. A neoprene insulator or equivalent should be placed between the fixing clip and heat sensing cable.
	Ensure any cable glands used are tightened to form a secure and moisture proof seal around the detection cable.
	Avoid allowing the detection cable to come in contact with any material which acts as a heat sink. This may delay the activation of the cable in alarm situations.
	Do not exceed the maximum operating voltage of the detection cable (48Vdc).
	Do not connect two lengths of detection cable which have different action temperatures.
	Do not connect lengths of fixed temperature cable in 'T' connections or spurs.
	Do not paint the detection cable.
	Do not place the detection cable under excessive tension.
	Do not bend the detection cable at right angles. The minimum bend radius is 2" or 50mm.
	Avoid subjecting the detection cable to mechanical damage which could result in false activation.
	Avoid laying the detection cable in areas where heavy traffic may result in the cable being crushed.

8.2 Sensor Cable Splicing

If the fixed temperature linear heat detection cable gets damaged or has triggered due to an overheat condition, the section can be removed and a new section spliced in its place.

Care should be taken during splicing to ensure the two core conductors do not come into contact with each other at any point and the final spliced joint is secure and made waterproof. A junction box can be used if required however it is also acceptable to splice together two ends of detection cable using a connection box and seal the splice using sealant tape (see figure 11).

 **When replacing a section of the detection cable due to an overheat condition having occurred, the section including at least 3m (10ft) either side of the known event should be replaced.**

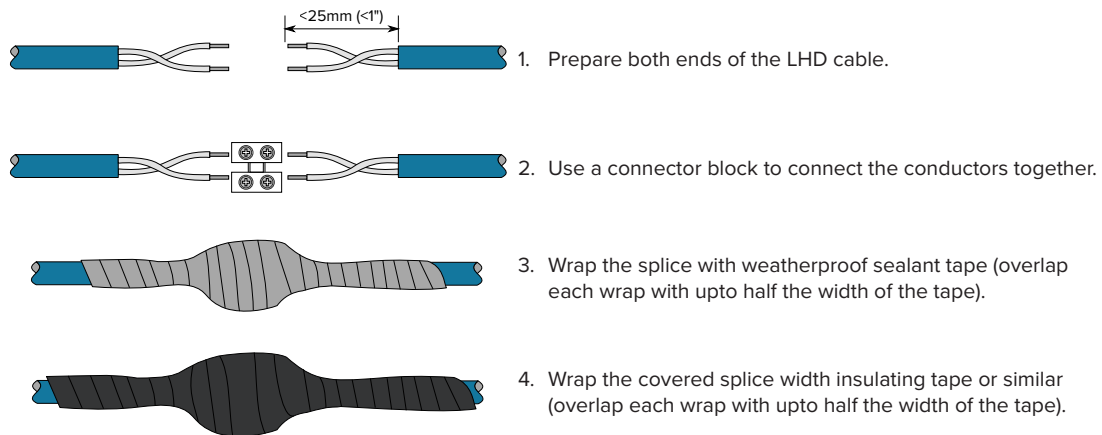

Figure 13: Splicing together joints in LHD cable

9 Sensor Cable Testing And Verification

Routine maintenance and checking should be carried out to ensure the Linear Heat Detection cable will function as expected and has not been damaged etc.

A visual inspection should be performed to ensure all support brackets and other aspects of the physical installation are suitable. The cable should also be visual checked for damage to the outer or inner insulation. Check to make sure the neoprene insulators are correctly installed around the cable in the clips.

Any joints which have been made should be checked to make sure they are secure and the sealant or insulating tape has not begun to come off. New tape should be applied if necessary.

Electrical tests should be carried out to determine the circuit created by the conductors is working. Remove the conductors from the fire alarm control panel or addressable switch monitor and measuring the resistance across them. The resulting value should equal the end of line resistance plus approximately $100\Omega/\text{km}$ for each leg.

To test in circuit with a fire alarm control panel or addressable switch monitor re-attach the LHD cable. Shorting out the end of line device should put the system into alarm. Disconnecting either leg from the end of line device should put the system into fault.

10 Functional Testing

Fixed Temperature Linear Heat Detection Cable is non-restorable – any section which has alarmed must be cut out and replaced. Therefore functional testing of the installed cable will not normally be carried out.

However, if required, any LHD cable leftover after installation can be used to periodically perform a functional test. A 1m (3ft) section of cable should be attached between the end of the LHD cable run and the end of line device.

Using a suitable device, heat the test length of detection cable up. Once the action temperature (including any tolerances) has been reached the system should alarm.

Ensure the test length is removed before placing the system back into normal operation

This page is intentionally left blank.

